

HAMPTON BAY®

Item #1001 509 809
Model SL-200-12A

USE AND CARE GUIDE

TRANSFORMER

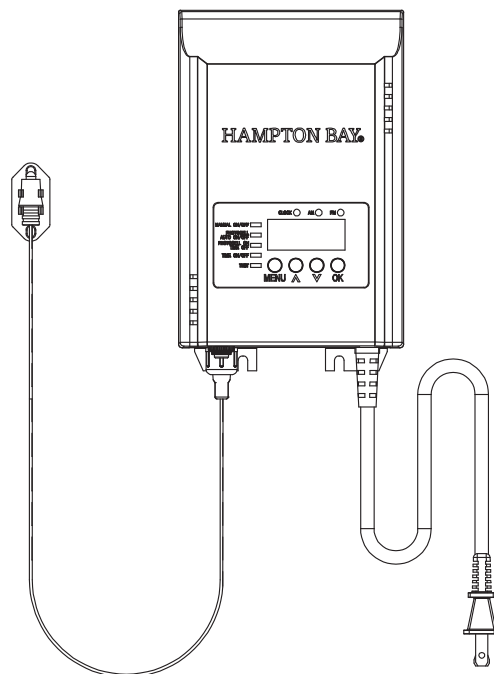

Questions, problems, missing parts? Before returning to the store,
call Hampton Bay Customer Service
8 a.m. - 7 p.m., PST, Monday Friday, 9 a.m. - 6 p.m., PST, Saturday

1-855-HD-HAMPTON

HAMPTONBAY.COM



THANK YOU

We appreciate the trust and confidence you have placed in Hampton Bay through the purchase of this transformer. We strive to continually create quality products designed to enhance your home. Visit us online to see our full line of products available for your home improvement needs. Thank you for choosing Hampton Bay!

Table of Contents

Table of Contents	2	Hardware Included	4
Safety Information	2	Package Contents	4
Warranty	3	Installation	5
What is Covered	3	Operation	8
What is Not Covered	3	Troubleshooting	10
Pre-installation	4	Cable Selection Chart	10
Tools Required	4		

Safety Information

IMPORTANT SAFETY INFORMATION TO REDUCE RISK OF FIRE OR INJURY.

- ◆ The secondary wiring is intended for shallow burial .(less than 6 inches / 152mm)
- ◆ For use with low voltage outdoor landscape lighting system only.
- ◆ There are no serviceable parts inside the power supply unit. DO NOT DISASSEMBLE.
- ◆ Do not submerge transformer.
- ◆ Do not connect two or more transformers in parallel.
- ◆ Do not use with a dimmer.
- ◆ Plug the power supply unit directly into a GFCI wet location outlet.
- ◆ Do not use an extension cord.
- ◆ The maximum output of this transformer is 200 watts. Do not overload the transformer. Be sure that the total cumulative wattage of all 12 volt fixtures connected to the transformer is equal to or less than 200 watts.
- ◆ “For best performance and to limit operation of the automatic thermal protector, do not install where air flow around the unit is overly restricted.”



PLEASE NOTE: This landscape light system must be installed in accordance with all local codes and ordinances. If you are experiencing problems, contact a qualified electrician.



WARNING: Risk of Electric Shock. Install power unit 5 feet (1.5 m) or more from a pool, spa, or fountain. Where the power unit is installed (a) indoors within 10 feet (3.0 m) of a pool, spa, or fountain or (b) outdoors, connect power unit to a receptacle protected by a GFCI.



WARNING: Changes or modifications to this unit not expressly approved by the party responsible for compliance could void the user's authority to operate the equipment.



Note: This equipment has been tested and found to comply with the limits for a Class B digital device, pursuant to part 15 of the FCC Rules. These limits are designed to provide reasonable protection against harmful interference in a residential installation. This equipment generates, uses and can radiate radio frequency energy and, if not installed and used in accordance with the instructions, may cause harmful interference to radio communications. However, there is no guarantee that interference will not occur in a particular installation. If this equipment does cause harmful interference to radio or television reception, which can be determined by turning the equipment off and on, the user is encouraged to try to correct the interference by one or more of the following measures:

- Reorient or relocate the receiving antenna.
- Increase the separation between the equipment and receiver.
- Connect the equipment into an outlet on a circuit different from that to which the receiver is connected.
- Consult the dealer or an experienced radio/TV technician for help.

Warranty

WHAT IS COVERED

The manufacturer warrants this transformer to be free from defects in materials and workmanship for a period of two (2) years from date of purchase. This warranty applies only to the original consumer and only to products used in normal use and service. If this product is found to be defective, the manufacturer's only obligation, and your exclusive remedy, is the repair or replacement of the product at the manufacturer's discretion, provided that the product has not been damaged through misuse, abuse, accident, modifications, alterations, neglect or mishandling.

WHAT IS NOT COVERED

This warranty shall not apply to any product that is found to have been improperly installed, set-up, or used in any way not in accordance with the instructions supplied with the product. This warranty shall not apply to a failure of the product as a result of an accident, misuse, abuse, negligence, alteration, or faulty installation, or any other failure not relating to faulty material or workmanship. This warranty shall not apply to the finish on any portion of the product, such as surface and/or weathering, as this is considered normal wear and tear.

The manufacturer does not warrant and specially disclaims any warranty, whether express or implied, of fitness for a particular purpose, other than the warranty contained herein. The manufacturer specifically disclaims any liability and shall not be liable for any consequential or incidental loss or damage, including but not limited to any labor / expense costs involved in the replacement or repair of said product.

Contact the Customer Service Team at 1-855-HD-HAMPTON or visit www.HamptonBay.com.

Pre-installation



WARNING: Use only CSA or UL approved low-voltage cable. Failure to use at least 16 gauge minimum cable or install it as directed in these instructions may result in Risk of Fire or Electric Shock. Using large cable will ensure maximum light output.

TOOLS REQUIRED



Claw hammer



Electrician knife

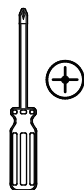

Phillips screwdriver

HARDWARE INCLUDED



NOTE: Hardware not shown to actual size.

PACKAGE CONTENTS

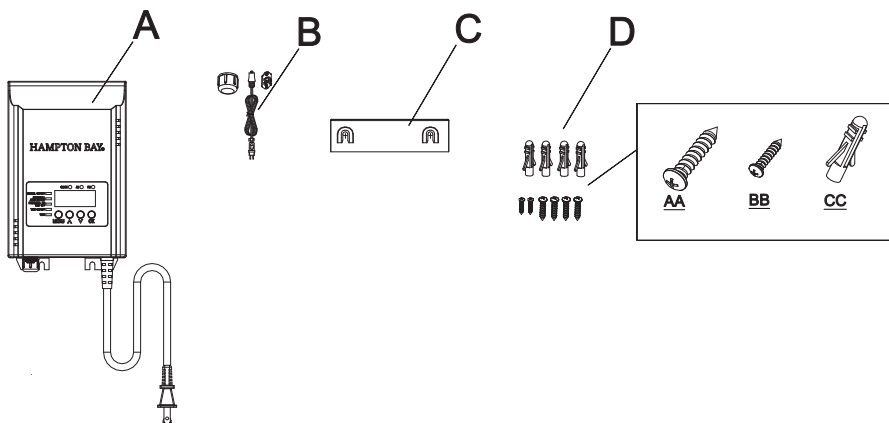

Part	Description	Quantity
A	Transformer	1
B	Photocell	1
C	Mounting Template	1
D	Hardware pack <ul style="list-style-type: none"> • AA Screw 4.8X30. (QTY 4) • BB Screw 3.5X15 (QTY 2) • CC Wall anchor (QTY 4) 	1

Installation

1 Preparing the Cable

Being careful when splitting NOT to expose the copper wire, remove the landscape wire insulation 1/2 in. from both wires and twist ends. Also, refer to strip length guide on the transformer.

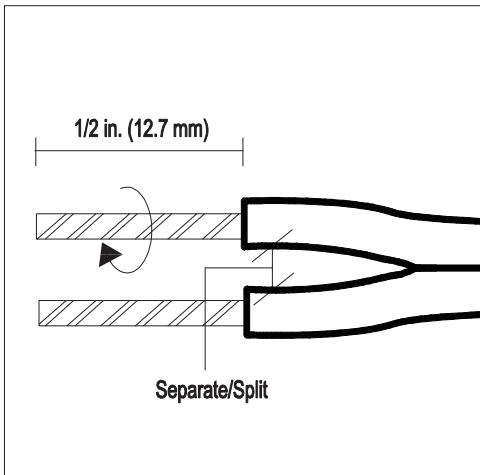

2 Connecting the Cable to the Transformer

Lay the transformer on a flat, stable surface and insert the stripped end of one wire under the terminal clamping plate "COM". Then tighten the screw. Repeat this procedure for clamping plate "12V" or "15V".

See cable selection chart for correct voltage tap.

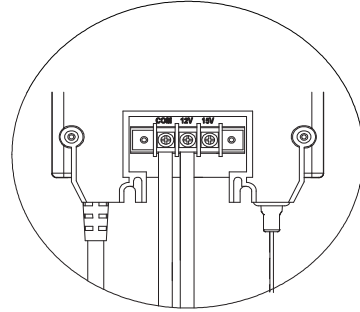

NOTE: Gently pull on the landscape wire to verify if the connection is strong.

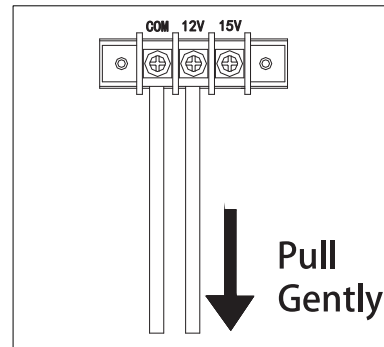

NOTE: Verify that there are no loose cable strands.

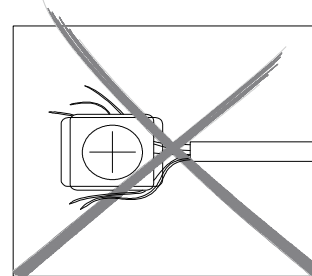

WARNING: Risk of Fire

Make sure there is no wire insulation under the clamping plate and firmly tighten the terminal screws.

Installation (continued)

3 Placing Your Fixtures and Routing the Cable

Lay your fixtures (not included) out where you want to locate them. Be sure do not exceed 200 watt rating of the transformer. Route the low voltage cable to the fixtures. If there is extra cable, coil after the last fixture.



WARNING: Risk of Electric Shock. Install power unit 5 feet (1.5 m) or more from a pool, spa, or fountain. Where the power unit is installed (a) indoors within 10 feet (3.0 m) of a pool, spa, or fountain or (b) outdoors, connect power unit to a receptacle protected by a GFCI.

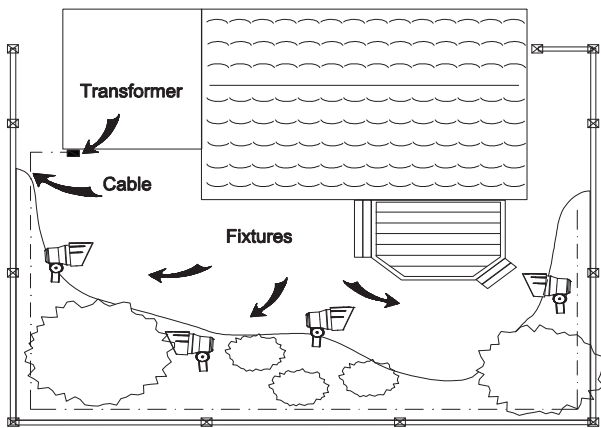

4 Attaching Your Fixtures

Turn the transformer on. Attach your fixtures to the cable to using cable connectors as shown. Place one connector on each side of the cable, then press together to lock. Prongs will pierce the cable to make contact and your fixtures should light up.

Turn the transformer on. Attach your fixtures to the cable using the cable connectors as shown. Press the connector tight onto the cable until the prongs pierce the cable insulation. The fixture should light on

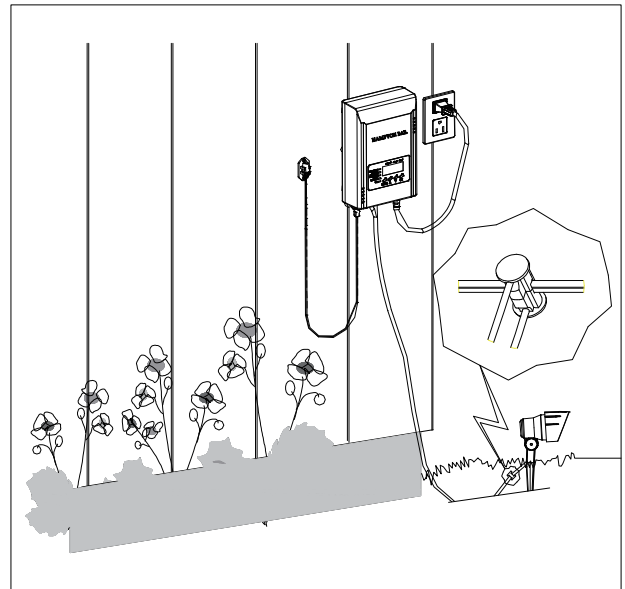

Installation (continued)

5 Mounting the Transformer

To mount directly to a wall surface use the included screws (AA) as shown, suitable for mounting within 12 in. to 48 in. (0.3 m to 1.2 m) of the ground. When installing the screws, the spacing between the screw centers is 3.35 in. (85 mm). See the template (C) for correct spacing. Hang the transformer (A) onto the screws (AA).

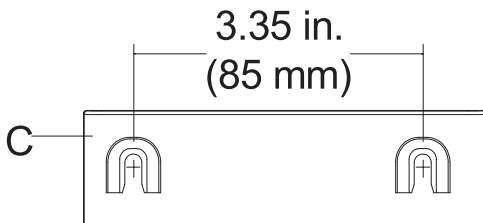
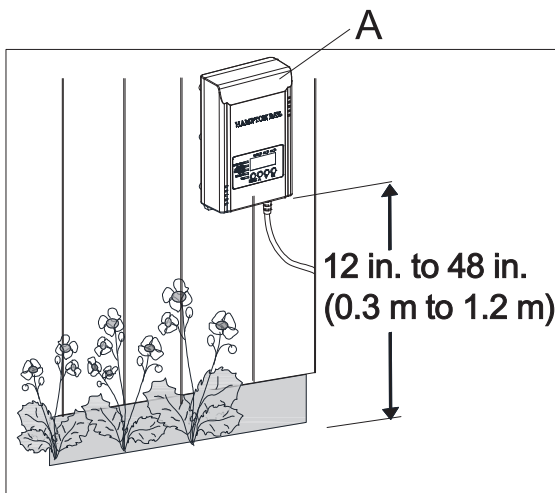

Mounting Template

7 Protecting or Hiding the Cable

Once all fixtures are in place and you are satisfied with their locations, the cable may be covered with mulch or buried up to 6 in. (15 cm) deep. Leave about 12 in. (30 cm) of cable after the last fixture.



WARNING: Risk of Fire

DO not coil cable around transformer. Total bulb wattages must not exceed a maximum of 200 watts.

6 Mounting the Photocell

Mount the photocell (B) bracket on a wall or other solid surface with the screws (BB) provided. Snap the sensor into the bracket. Route or coil the excess wire to protect it from lawn mowers, trimmers, etc. Make sure the sensor not point the light source at night time. Such as path light

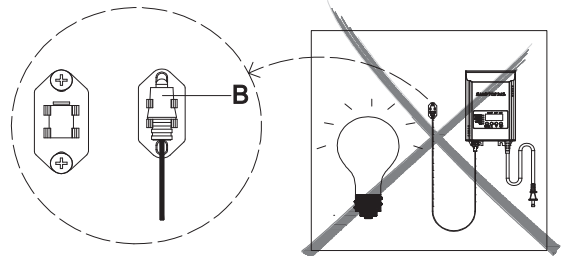

Placing the sensor in areas receiving less sunlight at dusk (east side of house, behind trees and bushes, under a deck) will have the transformer turn on earlier in the evening. Mounting the photocell in brighter locations will have the transformer turn on when it has become dark outside. The location, position and orientation of the photocell can be adjusted until the transformer turns on at the desired light level.

If the wires to the photocell are cut or broken, the photocell can be replaced. Unscrew the photocell connector cover from the transformer and pull the bi-pin connector out of the mating socket. The replacement part is inserted into the socket and the cap is screwed back onto the socket to provide a water tight connection. Note that the bi-pin connector is polarized and can be inserted into the socket only one way. The photo eye operation can be tested by turning the transformer mode to TEST.

Replacement photocell is available in the store.

Cover the connection hole with the dust cap when no photocell control wire is connected.

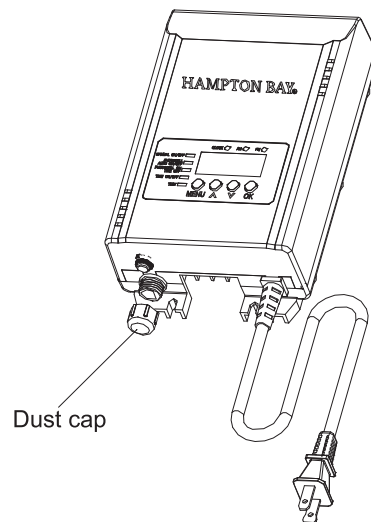

Operation

1 Setting the Clock

This setting allows you to set the clock to local time.

- Press MENU until CLOCK LED indicator is lit and the digit indicator is flashing. Then press OK.
- When AM and PM begins to flash, press the UP or DOWN arrow button to select AM or PM and press OK.
- When the Hour begins to flash, press the UP or DOWN arrow to desired hour and press OK.
- When the Minute begins to flash, press the UP or DOWN arrow to desired Minute and press OK.
- The Clock setting is now complete.



NOTE: To scroll through the clock settings more quickly, press and hold down the UP and DOWN arrows.

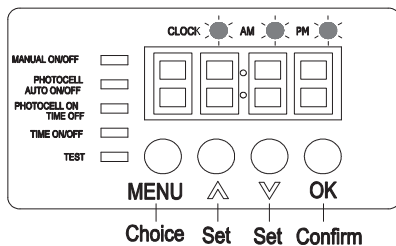

2 Operating in Manual Mode

This setting allows you to immediately turn the lights on and turn them off when you no longer need them.

- Press MENU until MANUAL ON/OFF LED indicator is lit and then press OK.
- The MANUAL ON/OFF mode is now set to ON. Press the UP arrow button to turn on the lights. Press the DOWN arrow button to turn off the lights.

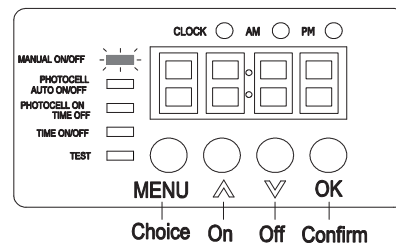

3 Setting PHOTOCELL AUTO ON/OFF

This setting allows the photocell to turn the lights on at dusk and off at dawn.

- Press MENU until the PHOTOCELL AUTO ON/OFF LED indicator is lit and then press OK. The PHOTOCELL AUTO ON/OFF mode is now activated. The digit display shows the current time and the AM/PM LED indicator stays lit.
- The start delay time is 0.1 sec. \pm 1 sec. ; The off delay time is 60 sec. \pm 10 sec.

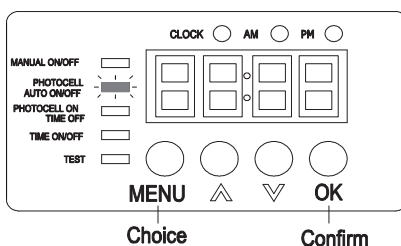

4 Setting PHOTOCELL ON / TIME OFF

This setting allows the photocell to turn the lights on and you set the time they go off.

- Press MENU until the PHOTOCELL ON / TIME OFF LED indicator is lit and press OK. The display shows "OFF" and press OK.
- When AM and PM begins to flash, press the UP or DOWN arrow button to select AM or PM and press OK.
- When the Hour begins to flash, press the UP or DOWN arrow to desired hour and press OK.
- When the Minute begins to flash, press the UP or DOWN arrow to desired Minute and press OK.
- The setting is now complete. The PHOTOCELL ON/ TIMER OFF LED indicator stays lit and the display shows the current time. The lights will automatically turn on at night and will turn off on the setting time.

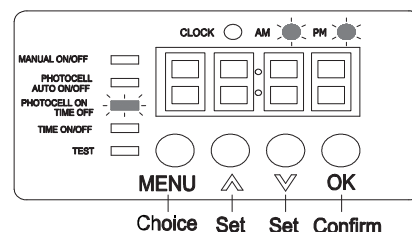

Operation (continued)

5 Setting the TIME ON/OFF

This setting allows you to control the time the lights turn on and when they will go off.

- Press MENU until the TIME ON/OFF LED indicator is lit and press OK. The digit display shows "ON" and press OK.
- When the AM and PM LED begin to flash, press the UP or DOWN arrow button to select AM or PM and press OK.
- When the Hour begins to flash, press the UP or DOWN arrow to desired hour and press OK.
- When the Minute begins to flash, press the UP or DOWN arrow to desired Minute and press OK.
- The display shows "OFF" indicating that you can now set the OFF time and press OK.
- When AM and PM begins to flash, press the UP or DOWN arrow button to select AM or PM and press OK.
- When the Hour begins to flash, press the UP or DOWN arrow to desired hour and press OK.
- When the Minute begins to flash, press the UP or DOWN arrow to desired Minute and press OK.

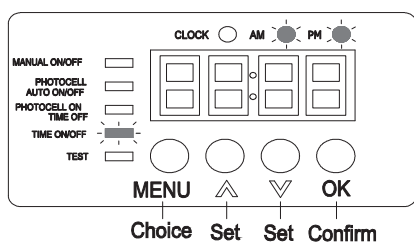

6 Using the TEST function

This setting allows you to test your landscape lighting after installation.

Press MENU until the TEST LED indicator is lit and press OK.

The time of photocell feeling the external light signal: the lights will turn on at dusk and off at dawn within 0.5 seconds.



NOTE: When using the TEST function during daylight hours with the photocell installed on the transformer, be sure to completely cover the photocell for the lights to turn on. The photocell needs to sense darkness in order to function, even in TEST mode. If no photocell is installed on the transformer, the lights will turn on regardless of daylight when using the TEST function.



NOTE: If you do not press "OK", the transformer defaults enter into the presently-set function within 10 seconds. In other modes outside of TEST, the transformer defaults enter into the presently -set function within 30 seconds.

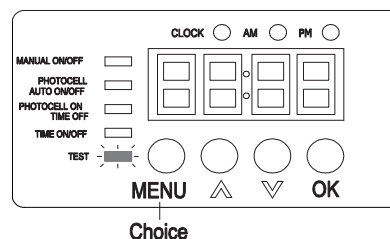

7 Power outage

In the event of a power outage the transformer functions may need to be reset.

8 Display Auto Shut-down

In TEST mode, the display and LED indicator lights on the transformer turn off after approximately 10 seconds of idle time. In all other modes, this auto shutdown occurs after approximately 120 seconds. Press any button to turn on the transformer display.

9 Restoring the Factory Settings

To restore the transformer to its original factory settings, press and hold the OK button for 3 seconds. The display shows 88:88 and resets to 12:00 after 1 second to indicate that the transformer is now restored to factory settings.

Troubleshooting

Problem	Probable Cause
All of the lights fail to work	<ul style="list-style-type: none"> • Check that the transformer power is on. • Check if there is a loose connection at the transformer screw terminal with the cable. • Check that the power switch is not in an OFF setting.
Only some lights work	<ul style="list-style-type: none"> • Check the connector to make sure the wire barbs have pierced the landscape cable. • Halogen or incandescent bulbs (if applicable) can be burned out. Use caution as the bulb can be hot.
The lights are on during the day	<ul style="list-style-type: none"> • The photocell is mounted in a dark area which causes the lights to turn on unnecessarily.
The lights do not switch on at dusk	<ul style="list-style-type: none"> • The photocell is mounted in an area that has too much constant light at night ,preventing the system from turning on.

Cable selection chart

12Volt Transformer Terminal

Terminal de transformador de 12 Voltios

Total Fixture Wattage Vataje total de la lámpara	Cable Length Largo del cable	Wire Gauge Calibre del cable
1-120	50ft	16
121-240		14
241-300*		12
0-60	100ft	16
61-120		14
121-240		12
0-60	150ft	14
61-120		12

15Volt Transformer Terminal

Terminal de transformador de 15 Voltios

Total Fixture Wattage Vataje total de la lámpara	Cable Length Largo del cable	Wire Gauge Calibre del cable
1-120	100ft	16
121-240		14
241-300*		12
0-60	150ft	14
61-120		12

* Not recommended for Halogen Landscape.



NOTE: This data is provided as a general guideline. Actual performance will depend on the installation layout, the fixtures, and the condition of the cable.

HAMPTON BAY®

Questions, problems, missing parts? Before returning to the store,
call Hampton Bay Customer Service
8 a.m. - 7 p.m., PST, Monday Friday, 9 a.m. - 6 p.m., PST, Saturday

1-855-HD-HAMPTON

HAMPTONBAY.COM

Retain this manual for future use.