

# HAMPTON BAY®

Item #100 277 0548  
Model SL-60-12-SV

## USE AND CARE GUIDE

### TRANSFORMER

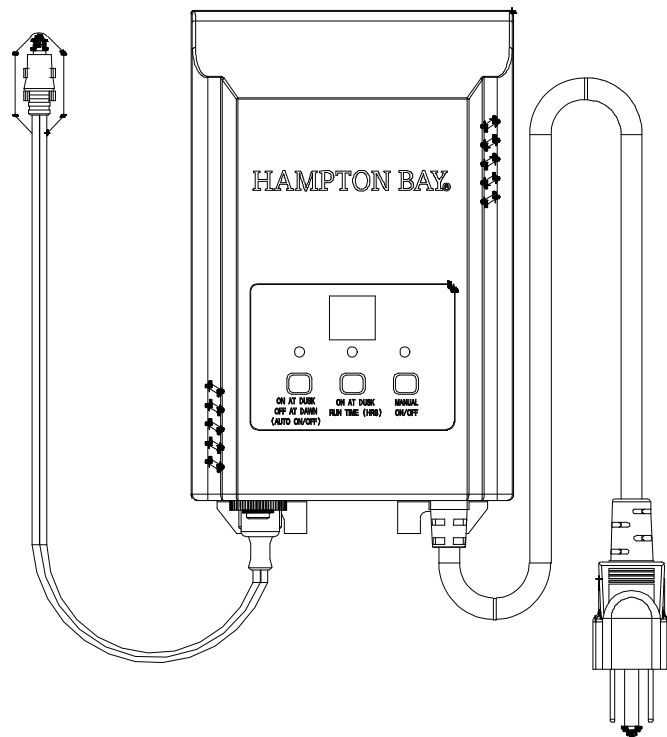

Questions, problems, missing parts? Before returning to the store,  
call Hampton Bay Customer Service  
8 a.m. - 7 p.m., PST, Monday Friday, 9 a.m. - 6 p.m., PST, Saturday

**1-855-HD-HAMPTON**

**HAMPTONBAY.COM**



### THANK YOU

*We appreciate the trust and confidence you have placed in Hampton Bay through the purchase of this transformer. We strive to continually create quality products designed to enhance your home. Visit us online to see our full line of products available for your home improvement needs. Thank you for choosing Hampton Bay!*



# Table of Contents

Table of Contents .....	2	Hardware Included .....	4
Safety Information .....	2	Package Contents .....	4
Warranty .....	3	Installation .....	5
What is Covered .....	3	Operation .....	8
What is Not Covered .....	3	Troubleshooting .....	9
Pre-installation .....	4		
Tools Required .....	4		

# Safety Information

## IMPORTANT SAFETY INFORMATION TO REDUCE RISK OF FIRE OR INJURY.

- ◆ The secondary wiring is intended for shallow burial .( less than 6 inches / 152mm )
- ◆ For use with low voltage outdoor landscape lighting system only.
- ◆ There are no serviceable parts inside the power supply unit. DO NOT DISASSEMBLE.
- ◆ Do not submerge transformer.
- ◆ Do not connect two or more transformers in parallel.
- ◆ Do not use with a dimmer.
- ◆ Plug the power supply unit directly into a GFCI wet location outlet.
- ◆ Do not use an extension cord.
- ◆ The maximum output of this transformer is 60 watts. Do not overload the transformer. Be sure that the total cumulative wattage of all 12 volt fixtures connected to the transformer is equal to or less than 60 watts.
- ◆ “For best performance and to limit operation of the automatic thermal protector, do not install where air flow around the unit is overly restricted.”



**PLEASE NOTE:** This landscape light system must be installed in accordance with all local codes and ordinances. If you are experiencing problems, contact a qualified electrician.



**WARNING: Risk of Electric Shock.** Install power unit 5 feet (1.5 m) or more from a pool, spa, or fountain. Where the power unit is installed (a) indoors within 10 feet (3.0 m) of a pool, spa, or fountain or (b) outdoors, connect power unit to a receptacle protected by a GFCI.



**WARNING:** Changes or modifications to this unit not expressly approved by the party responsible for compliance could void the user’s authority to operate the equipment.



**Note:**This equipment has been tested and found to comply with the limits for a Class B digital device, pursuant to part 15 of the FCC Rules. These limits are designed to provide reasonable protection against harmful interference in a residential installation. This equipment generates, uses and can radiate radio frequency energy and, if not installed and used in accordance with the instructions, may cause harmful interference to radio communications. However, there is no guarantee that interference will not occur in a particular installation. If this equipment does cause harmful interference to radio or television reception, which can be determined by turning the equipment off and on, the user is encouraged to try to correct the interference by one or more of the following measures:

- Reorient or relocate the receiving antenna.
- Increase the separation between the equipment and receiver.
- Connect the equipment into an outlet on a circuit different from that to which the receiver is connected.
- Consult the dealer or an experienced radio/TV technician for help.

# Warranty

---

## WHAT IS COVERED

The manufacturer warrants this transformer to be free from defects in materials and workmanship for a period of two (2) years from date of purchase. This warranty applies only to the original consumer and only to products used in normal use and service. If this product is found to be defective, the manufacturer's only obligation, and your exclusive remedy, is the repair or replacement of the product at the manufacturer's discretion, provided that the product has not been damaged through misuse, abuse, accident, modifications, alterations, neglect or mishandling.

## WHAT IS NOT COVERED

This warranty shall not apply to any product that is found to have been improperly installed, set-up, or used in any way not in accordance with the instructions supplied with the product. This warranty shall not apply to a failure of the product as a result of an accident, misuse, abuse, negligence, alteration, or faulty installation, or any other failure not relating to faulty material or workmanship. This warranty shall not apply to the finish on any portion of the product, such as surface and/or weathering, as this is considered normal wear and tear.

The manufacturer does not warrant and specially disclaims any warranty, whether express or implied, of fitness for a particular purpose, other than the warranty contained herein. The manufacturer specifically disclaims any liability and shall not be liable for any consequential or incidental loss or damage, including but not limited to any labor / expense costs involved in the replacement or repair of said product.

Contact the Customer Service Team at 1-855-HD-HAMPTON or visit [www.HamptonBay.com](http://www.HamptonBay.com).

# Pre-installation



**WARNING:** Use only UL Listed Underground low energy circuit cable or SPT-3 or SPT-2W. Failure to use at least 16 gauge minimum cable or install it as directed in these instructions may result in Risk of Fire or Electric Shock. Using large cable will ensure maximum light output.

## TOOLS REQUIRED

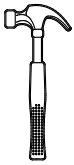

Claw hammer



Electrician knife

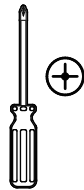

Phillips screwdriver

## HARDWARE INCLUDED



**NOTE:** Hardware not shown to actual size.

## PACKAGE CONTENTS

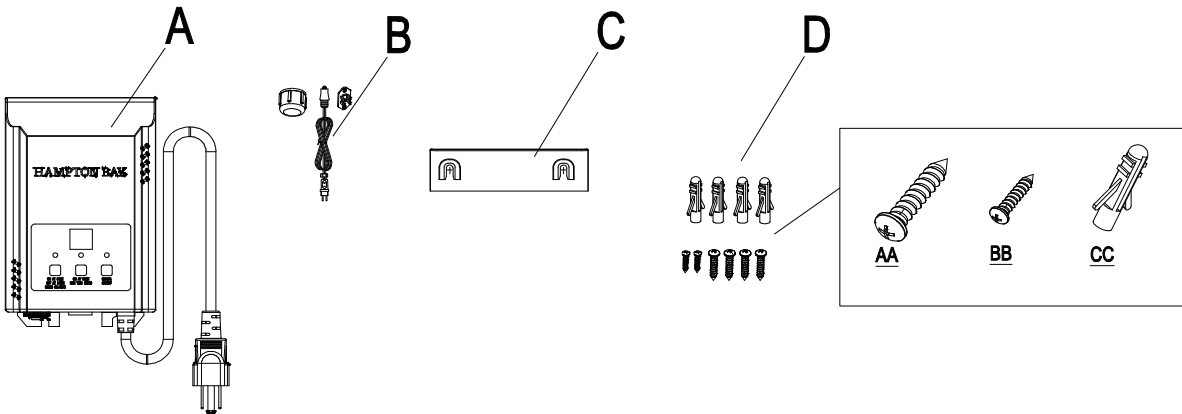

Part	Description	Quantity
A	Transformer	1
B	Photocell	1
C	Mounting Template	1
D	Hardware pack <ul style="list-style-type: none"> <li>• AA Screw 4.8X30. (QTY 4)</li> <li>• BB Screw 3.5X15 (QTY 2)</li> <li>• CC Wall anchor (QTY 4)</li> </ul>	1

# Installation

## 1 Preparing the Cable

Being careful when splitting NOT to expose the copper wire, remove the landscape wire insulation 1/2 in. from both wires and twist ends. Also, refer to strip length guide on the transformer.

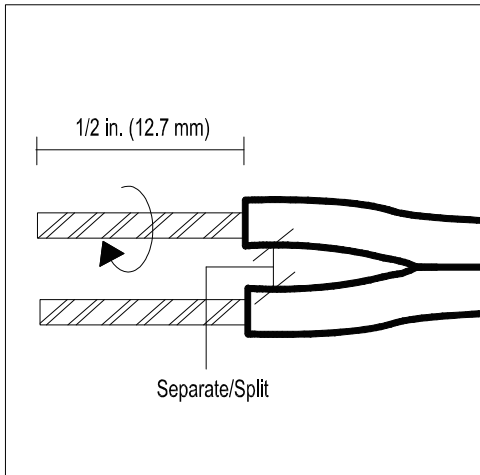

## 2 Connecting the Cable to the Transformer

Lay the transformer on a flat, stable surface and insert the stripped end of one wire under the terminal clamping plate "COM". Then tighten the screw. Repeat this procedure for clamping plate "12V" or "15V".

See cable selection chart for correct voltage tap.

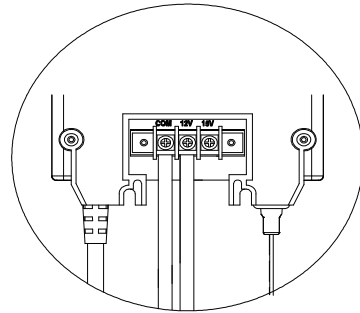

**NOTE:** Gently pull on the landscape wire to verify if the connection is strong.

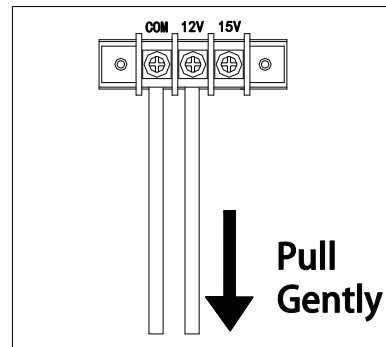

**NOTE:** Verify that there are no loose cable strands.

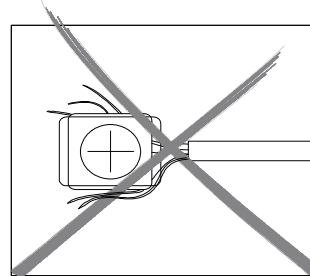

**WARNING: Risk of Fire**

Make sure there is no wire insulation under the clamping plate and firmly tighten the terminal screws.

## Installation (continued)

### 3 Placing Your Fixtures and Routing the Cable

Lay your fixtures (not included) out where you want to locate them. Be sure do not exceed 60 watt rating of the transformer.

Route the low voltage cable to the fixtures. If there is extra cable, coil after the last fixture.



**WARNING: Risk of Electric Shock.**

Install power unit 5 feet (1.5 m) or more from a pool, spa, or fountain. Where the power unit is installed (a) indoors within 10 feet (3.0 m) of a pool, spa, or fountain or (b) outdoors, connect power unit to a receptacle protected by a GFCI.

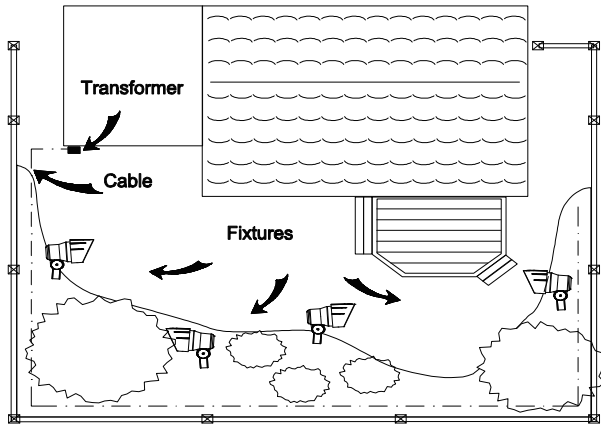

### 4 Attaching Your Fixtures

Turn the transformer on. Attach your fixtures to the cable to using cable connectors as shown. Place one connector on each side of the cable, then press together to lock. Prongs will pierce the cable to make contact and your fixtures should light up.

Turn the transformer on. Attach your fixtures to the cable using the cable connectors as shown. Press the connector tight onto the cable until the prongs pierce the cable insulation. The fixture should light on.

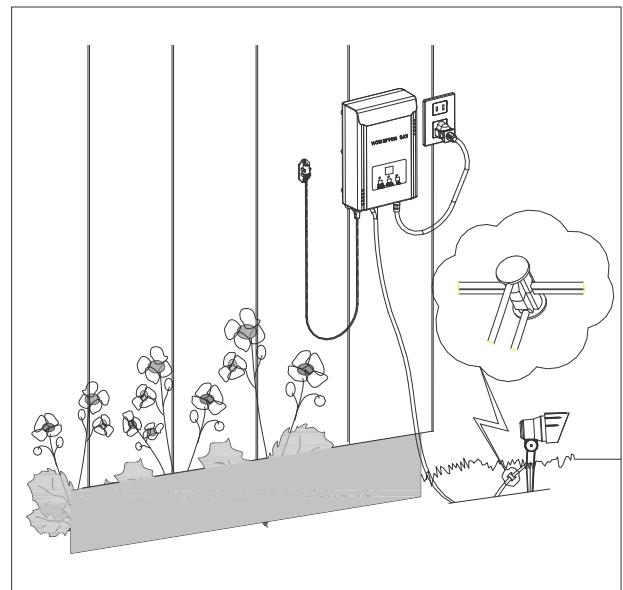

## Installation (continued)

### 5 Mounting the Transformer

To mount directly to a wall surface use the included screws (AA) as shown, suitable for mounting within 12 in. to 48 in. (0.3 m to 1.2 m) of the ground. When installing the screws, the spacing between the screw centers is 3.46 in. (88 mm). See the template (D) for correct spacing. Hang the transformer (A) onto the screws (AA).

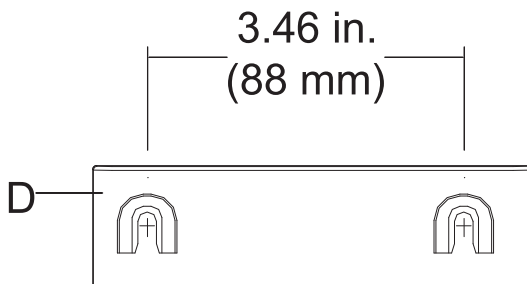
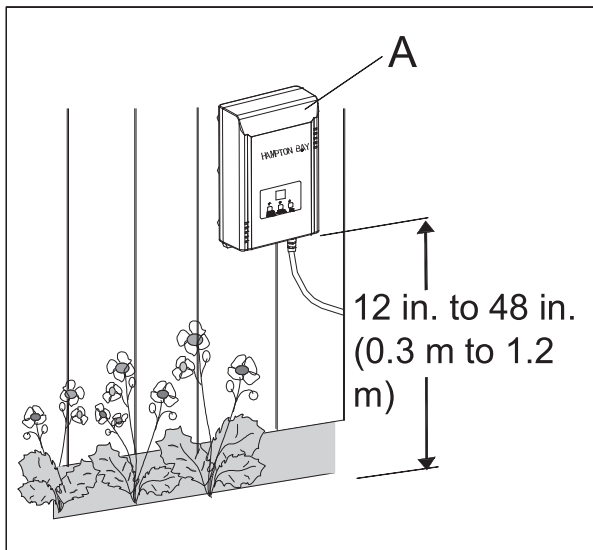

Mounting Template

### 7 Protecting or Hiding the Cable

Once all fixtures are in place and you are satisfied with their locations, the cable may be covered with mulch or buried up to 6 in. (15 cm) deep. Leave about 12 in. (30 cm) of cable after the last fixture.



**WARNING: Risk of Fire**

DO not coil cable around transformer. Total bulb wattages must not exceed a maximum of 60 watts.

### 6 Mounting the Photocell

Mount the photocell (B) bracket on a wall or other solid surface with the screws (BB) provided. Snap the sensor into the bracket. Route or coil the excess wire to protect it from lawn mowers, trimmers, etc. Make sure the sensor not point the light source at night time. Such as path light

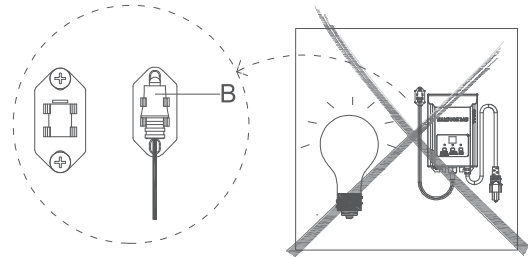

Placing the sensor in areas receiving less sunlight at dusk (east side of house, behind trees and bushes, under a deck) will have the transformer turn on earlier in the evening. Mounting the photocell in brighter locations will have the transformer turn on when it has become dark outside. The location, position and orientation of the photocell can be adjusted until the transformer turns on at the desired light level.

If the wires to the photocell are cut or broken, the photocell can be replaced. Unscrew the photocell connector cover from the transformer and pull the bi-pin connector out of the mating socket. The replacement part is inserted into the socket and the cap is screwed back onto the socket to provide a water tight connection. Note that the bi-pin connector is polarized and can be inserted into the socket only one way.

Replacement photocell is available in the store.

Cover the connection hole with the dust cap when no photocell control wire is connected.

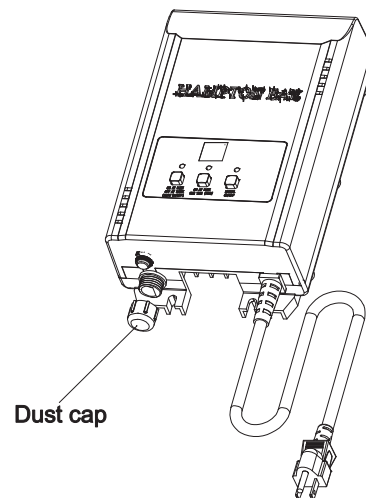



# Operation

## 1 ON AT DUSK/OFF AT DAWN (Factory default setting)

In this mode, the landscape lights will automatically turn on at dusk and turn off at dawn.  
Press ON AT DUSK /OFF AT DAWN button, the related indicator light will illuminate and “AU” (Auto) will display on screen. This mode is now active.

 **NOTE:**The photocell sensor should be installed and secured tightly before transformer operation is set

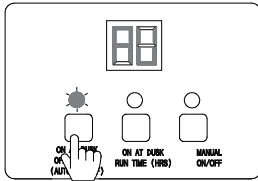

## 2 ON AT DUSK /RUN TIME

In this mode, the landscape lights will automatically turn on at dusk and off after the set time (hrs).  
Press ON AT DUSK /RUN TIME button, the related indicator light will illuminate. Increase RUN TIME by pressing ON AT DUSK/RUN TIME button repeatedly until desired RUN TIME is displayed (The time will be displayed as 1,2,...,12 hours).

 **NOTE:**The photocell sensor should be installed and secured tightly before transformer operation is set

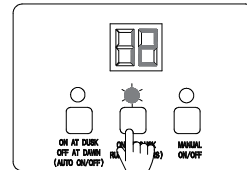

## 3 MANUAL ON/OFF

In this mode, the landscape lights can be turned on & off manually.  
Press the MANUAL ON/OFF button, the related indicator light will illuminate. The transformer has now entered MANUAL ON/OFF MODE. Display will first show OFF mode, press button again to toggle landscape lights ON.

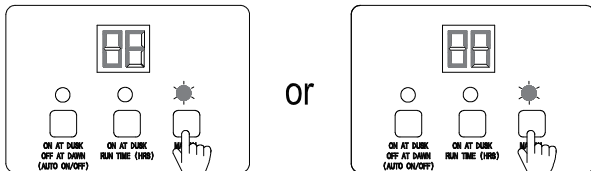

## 4 Restore factory function

In any mode, press & hold MANUAL ON/OFF button for 10 seconds, “88” will be displayed on the screen and all the indicator lights will illuminate. The transformer will reset to ON AT DUSK /OFF AT DAWN mode.

 **NOTE:**After 30 seconds the transformer display will go into standby mode, press any button to remove transformer from standby mode

 **NOTE:**Transformer will retain settings in the event of complete power loss

# Troubleshooting

Problem	Probable Cause
All of the lights fail to work	<ul style="list-style-type: none"><li>• Check that the transformer power is on.</li><li>• Check if there is a loose connection at the transformer screw terminal with the cable.</li><li>• Check that the power switch is not in an OFF setting.</li></ul>
Only some lights work	<ul style="list-style-type: none"><li>• Check the connector to make sure the wire barbs have pierced the landscape cable.</li><li>• Halogen or incandescent bulbs (if applicable) can be burned out. Use caution as the bulb can be hot.</li></ul>
The lights are on during the day	<ul style="list-style-type: none"><li>• The photocell is mounted in a dark area which causes the lights to turn on unnecessarily.</li></ul>
The lights do not switch on at dusk	<ul style="list-style-type: none"><li>• The photocell is mounted in an area that has too much constant light at night ,preventing the system from turning on.</li></ul>



# **HAMPTON BAY®**

Questions, problems, missing parts? Before returning to the store,  
call Hampton Bay Customer Service  
8 a.m. - 7 p.m., PST, Monday Friday, 9 a.m. - 6 p.m., PST, Saturday

**1-855-HD-HAMPTON**

**HAMPTONBAY.COM**

Retain this manual for future use.